

General information

This Quick use guide gives a rough overview and helps to quickly start with basic steps. Please read the supplied user's manual for detailed information.

Supplied accessories

- ① 2 batteries for the remote control, type AA
- ② 1 remote control
- ③ 1 blank DVD+RW disc
- ④ 1 SCART cable
- ⑤ 1 cinch audio cable
- ⑥ 1 TV antenna cable
- ⑦ 1 FM antenna cable
- ⑧ 1 MW loop antenna
- ⑨ 1 AC mains cable
- ⑩ 7 speaker cables with colour coded ends
- ⑪ 2 front speakers and 2 rear speakers
- ⑫ 2 subwoofers integrated in the speaker stands
- ⑬ 1 centre speaker

Assembling the speakers

Subwoofers and front speakers

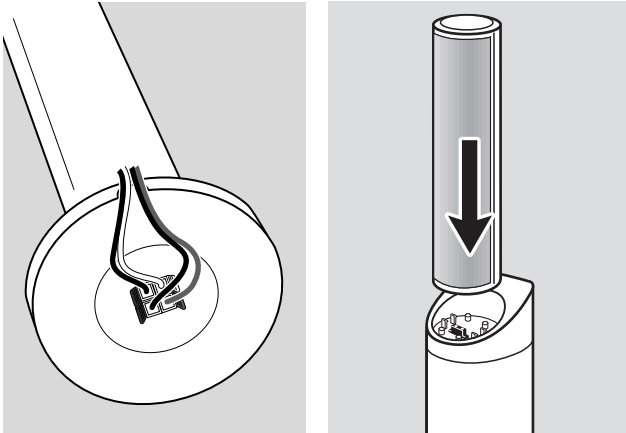

Rear speakers

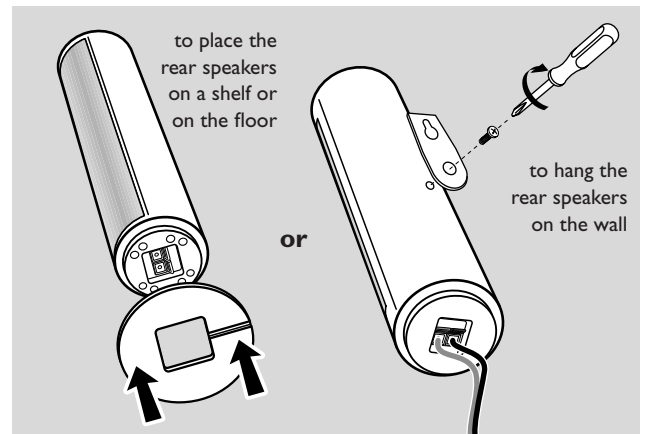

Positioning the speakers

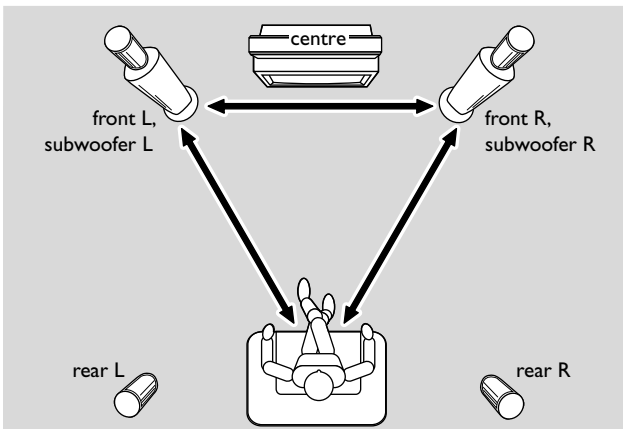

Connecting the speakers

Connect the speakers using the supplied speaker cables. Match the colours of the speaker sockets and the speaker cables:

Speaker	+	-
Front Left	white	black
Front Right	red	black
Centre	green	black
Subwoofer Left	violet	black
Subwoofer Right	violet	black
Rear Left	blue	black
Rear Right	grey	black

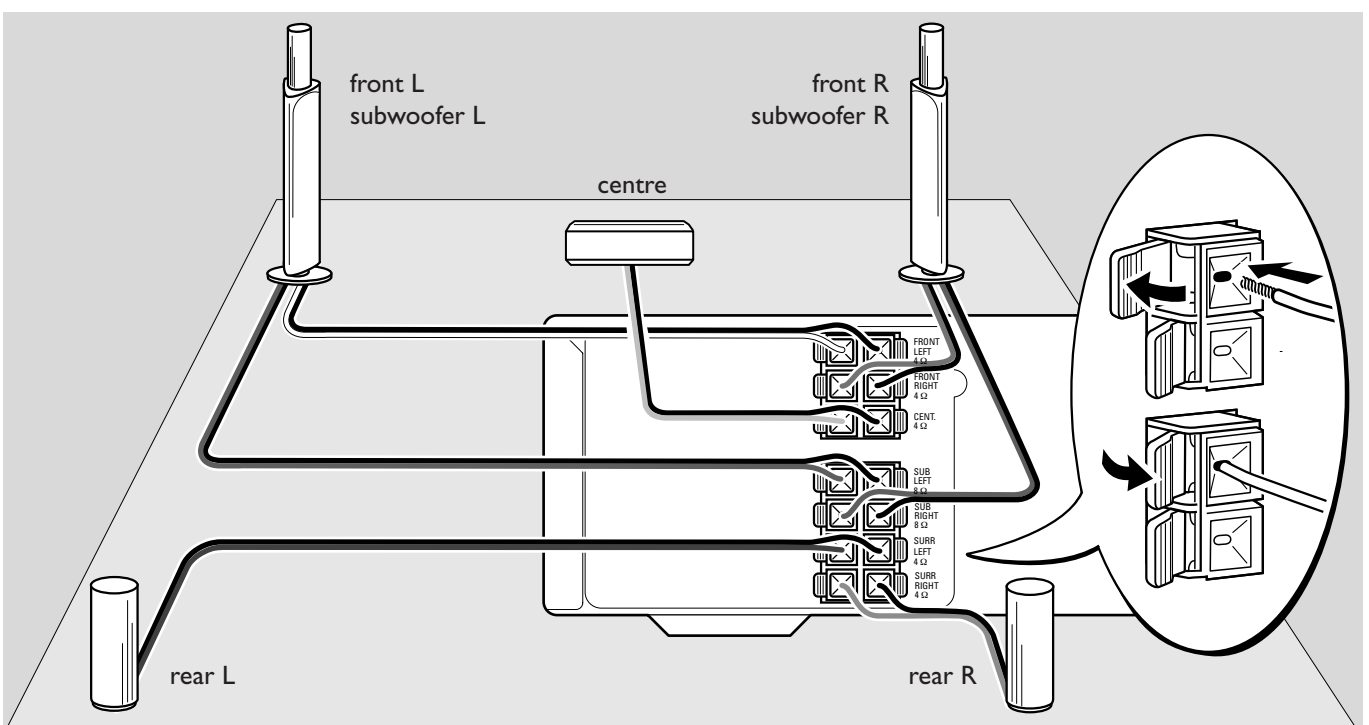

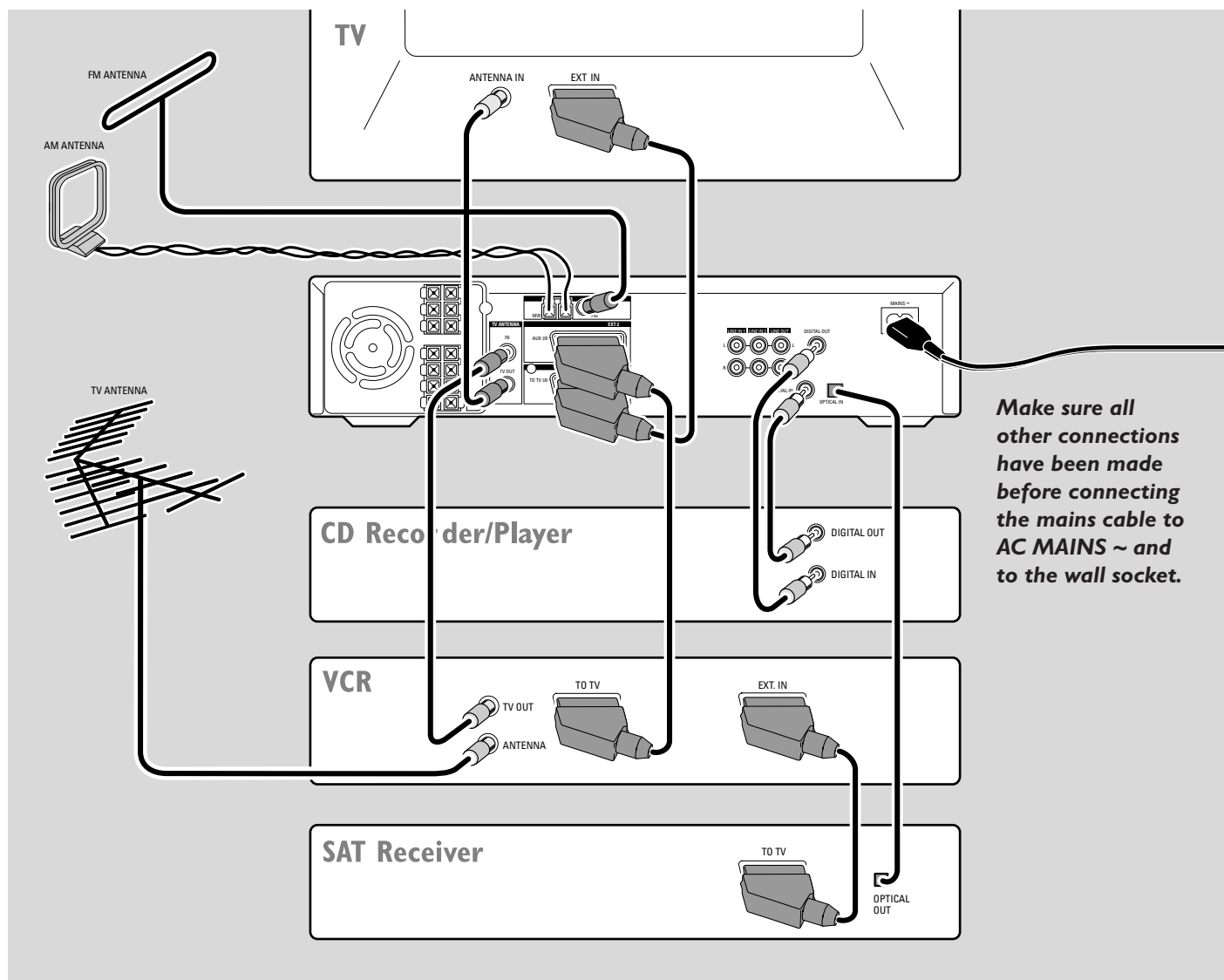

Make sure all other connections have been made before connecting the mains cable to AC MAINS ~ and to the wall socket.

Connections

Start inputs/outputs of your other appliances can be named:

- TO TV/MONITOR, EURO-AV OUT,...
- AUX, EXT, I/O, EURO-AV IN,...

Initial installation

When you connect the DVD recorder system to the mains supply for the first time, you need to perform some basic settings. Please observe the TV screen and the display of the DVD recorder system.

- 1** Switch on your TV.
- 2** Connect the supplied mains cable to AC MAINS ~ and to the wall socket. If the DVD recorder system is in demo mode, press to cancel the demo mode.
→ IS TV ON? is displayed on the DVD recorder system.

- 3** If necessary set the TV to the correct audio/video channel for the DVD recorder system. Such channels may be called AUX or AUXILIARY IN, AUDIO/VIDEO or AV IN, EXT1, EXT2 or EXTERNAL IN, etc. These channels are often near channel 00.

*Note: If your TV supports EasyLink, the TV and the DVD recorder system exchange information via the SCART cable. In this case, **EasyLink loading data from TV, please wait** will appear on the TV. Some of the following settings will be done automatically then.*

- 4** → The menu **Menu Language** appears on the TV screen.
Press or to select the language in which the display messages should appear on the TV screen. Then press OK.
- 5** → The menu **Audio language** appears.
Press or to select the language in which DVDs should preferably be played, if the language is available on the disc. Then press OK.

6 → The menu **Subtitle Language** appears.
 Press ▲ or ▼ to select the language in which subtitles should preferably be displayed, if subtitles in the language are available on the disc. Then press OK.

Note: Some DVDs may override your audio and subtitle language selection. In this case, you have to select the audio and subtitle language in the DVDs Disc Menu.

7 → The menu **TV Shape** appears.
 Press ▲ or ▼ to select the screen format. This setting will have an effect only with DVDs supporting different screen formats.
 → **4:3 letterbox**: for a wide-screen picture (cinema format) on a conventional 4:3 TV set with black borders at the top and bottom of the screen.
 → **4:3 panscan**: for a full-height picture with cropped edges.
 → **16:9**: for a wide-screen TV set.

Then press OK.

8 → The menu **Country** appears.
 Press ▲ or ▼ to select the country where the DVD recorder system is used. If your country does not appear, select **Other**. Then press OK.

9 → **If you have connected the antenna - press OK** appears.
 If you connected the DVD recorder system to a TV antenna or a cable TV system, press OK.
 If not, connect the antenna as described in "Connecting the TV antenna", then press OK.
 → **Autoinstall** appears and the automatic search for TV channels starts. This may take several minutes. As soon as the search is complete, **Autoinstall complete** appears.

10 Press SYSTEM MENU.
 → **CONTINUE WITH SPECIAL AUDIO SETTINGS** is scrolled on the DVD recorder system.

Next, you will be asked
 – about the distances between the speakers and your preferred listening position and
 – to which socket you connected your TV and other appliances.

11 **If you want to continue with these advanced settings:** Press OK. For details, see "Advanced settings" on page 17 in the user's manual.

If you do not want to continue, the standard settings below will be used for the speaker distances and the connections:

Press ▼ to select **NO**, then press OK to confirm.
 → **AUTOINSTALL** is displayed. The DVD recorder system searches for available radio stations and stores them in its memory.
 → After the search **INSTALLATION COMPLETE** is scrolled and a radio station is played. The DVD recorder system is ready to play.

Standard settings for the speaker distances and the connected appliances

To change these settings later on, see "When adding appliances or changing the connections of appliances" and "When changing the speaker setup" in the user's manual.

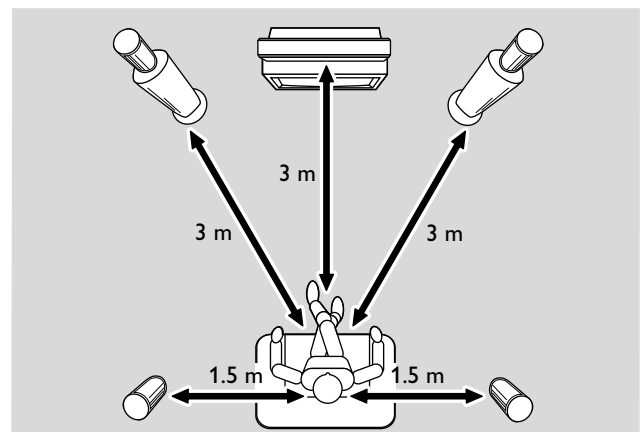

appliance	is connected to
TV	EXT 1 TO TV I/O
satellite receiver	EXT 2 AUX I/O
VCR (video recorder)	EXT 2 AUX I/O
game console	EXT 2 AUX I/O
CD player	DIGITAL IN
CD recorder	LINE IN 1
tape deck	LINE IN 2

Note: The satellite receiver, VCR and game console are connected in a "chain". See illustration on the page to the left.

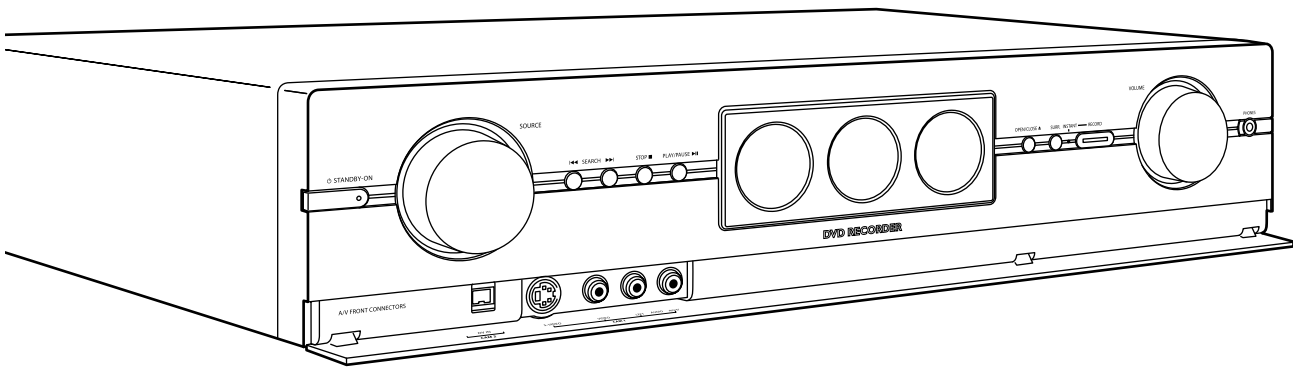

Discs for playback and recording

– DVD+R

can be recorded once and played on standard DVD players and DVD recorders, if finalised.



– DVD+RW

can be recorded, erased and re-recorded many times and played on DVD+RW compatible DVD players and DVD recorders if finalised.



Discs for playback only

Discs with the following logos can be played:



Playback

- 1 Press OPEN/CLOSE ▲ on the set to open the drawer and insert a disc (printed side up) in the tray.
- 2 Press OPEN/CLOSE ▲ on the set again. If necessary, press PLAY/PAUSE ►► to start playback.
 - To interrupt playback, press PLAY/PAUSE ►►.
 - To resume playback, press PLAY/PAUSE ►► again.
- 3 To stop playback press STOP.

Selecting a source

- Turn SOURCE on the DVD recorder system or keep a source key on the remote control pressed for 1 second to select either:
 - the disc in the DVD recorder system
 - MONITOR: the internal TV tuner of the DVD recorder system (only selectable by pressing DVD/MON on the remote control)
 - TV: the TV
 - CAM 1: a camcorder connected to CAM 1
 - CAM2: a camcorder connected to CAM 2
 - SAT: a connected satellite receiver
 - VCR: a connected VCR (video recorder)
 - GAME: a connected game console
 - the radio tuner of the DVD recorder system
 - TAPE: a connected tape deck or similar audio recording appliance
 - CD REC: a connected CD recorder
 - CD: a connected CD player/changer
- The sound of the source is played on the DVD recorder system.

Note: If SOURCE NOT AVAILABLE is scrolled please read "When adding appliances or changing the connections of appliances" in the user's manual.

Selecting a recording mode

- Before recording, press REC MODE repeatedly to select the desired recording mode:

mode	quality	recording time
HQ	better than DVD	60 minutes
SP	DVD	120 minutes
SP+	better than S-VHS	150 minutes
LP	S-VHS	180 minutes
EP	better than VHS	240 minutes
EP+	VHS	360 minutes

Recording a TV programme with safe record

- 1** Switch your TV set on. If necessary set the TV to the correct audio/video channel for the DVD recorder system. Such channels may be called AUX or AUXILIARY IN, AUDIO/VIDEO or A/V IN, EXT1, EXT2 or EXTERNAL IN, etc. These channels are often near channel 00.
- 2** Load a DVD+R disc or DVD+RW disc on which you want to record in the tray.
- 3** Press DVD/MON on the remote control as often as necessary to see the currently selected TV channel.
- 4** Press CH+ or CH- on the remote control as often as necessary to select the desired TV channel (programme number) from which you wish to record.
- 5** Keep REC/OTR on the remote control pressed until *SAFE RECO* is displayed.
- 6** Press STOP ■ to stop recording.

Recording from other appliances

- 1** Switch your TV set on. If necessary set the TV to the correct audio/video channel for the DVD recorder system. Such channels may be called AUX or AUXILIARY IN, AUDIO/VIDEO or A/V IN, EXT1, EXT2 or EXTERNAL IN, etc. These channels are often near channel 00.
- 2** Load a disc on which you want to record in the tray.
- 3** Press on the remote control either:
SAT: to record from a connected satellite receiver.
CAM1/2: to record from a connected video camera. Press the button repeatedly to toggle between camera 1 (analogue input) and camera 2 (digital i.Link input).
VCR/GAME: to record from a connected video cassette recorder or a game console. Press the button repeatedly to toggle between video cassette recorder and game console.
- 4** Press RECORD on the DVD recorder system or REC/OTR on the remote control to start recording.

Note: Recordings on a DVD+RW disc are started from the current position. From there on, earlier recordings may be overwritten without notice, unless the disc is write protected.
 - To interrupt recording press PLAY/PAUSE ►|| .
 - To resume recording press PLAY/PAUSE ►|| again.
- 5** Press STOP ■ to stop recording.